

Operational-technical documentation

ERC20 controller manual

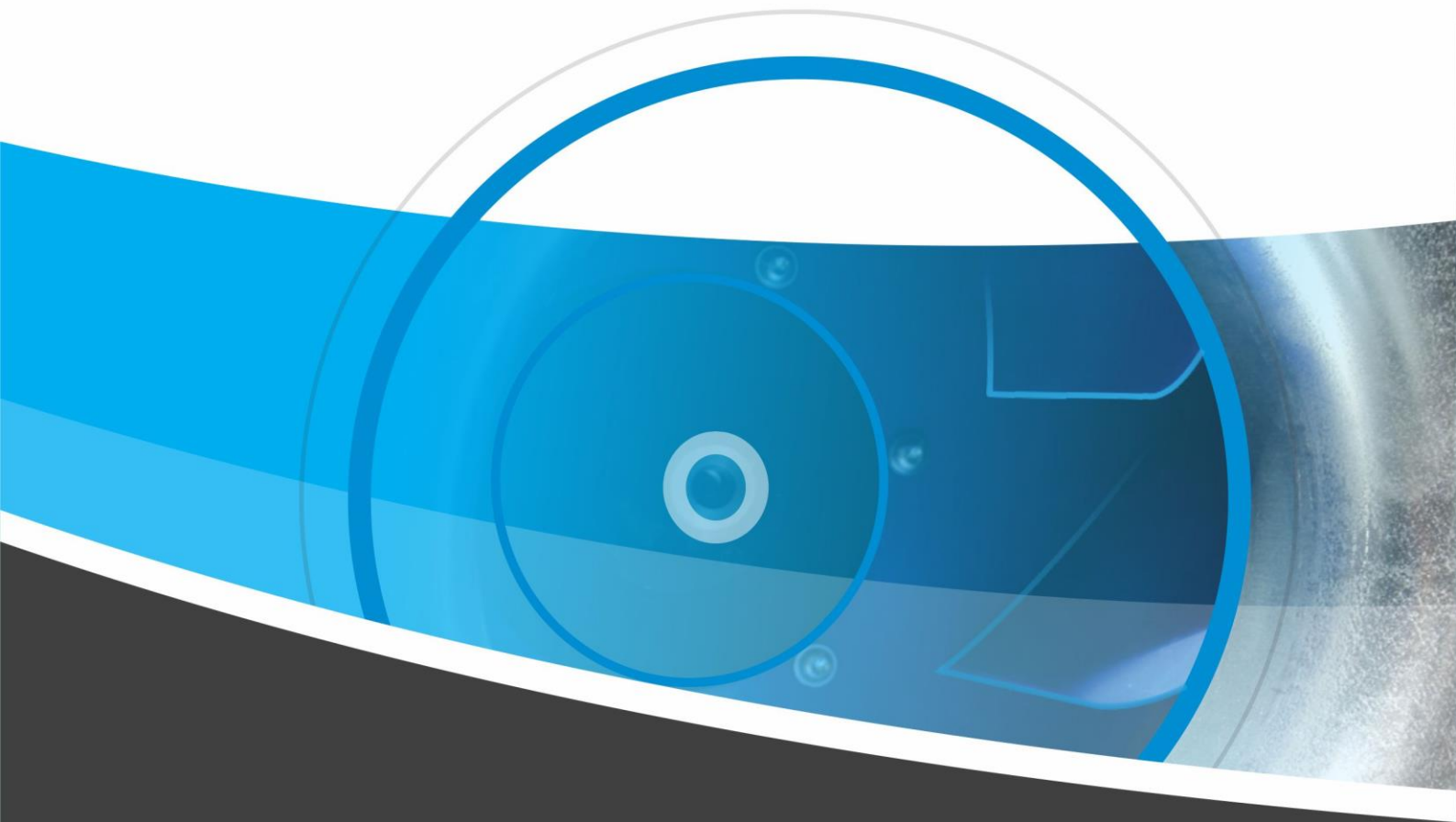

 **VentiAir**

Controller program version: from 5.0

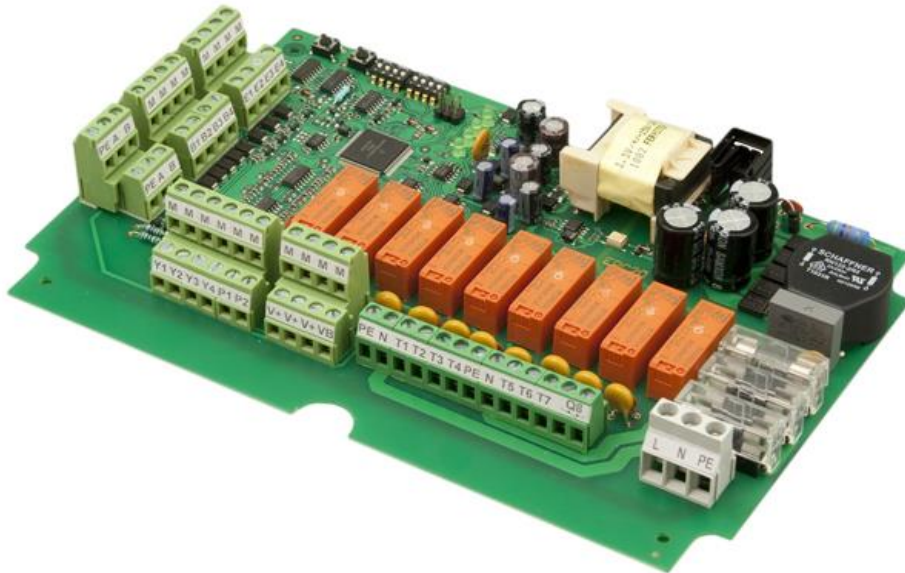

Contact information:

2

VentiAir s.r.o.
Adolfovice 512
790 01 Bělá pod Pradědem
CZ – Czech Republic
IČ: 06935320 DIČ: CZ06935320
email: obchod@ventiair.com; technical@ventiair.com
tel.: +420 602 500 287

The device is manufactured in accordance with the European standard EN1886, EN13053

This documentation must always be handed over to the customer!

In case of non-compliance with the conditions stated in this documentation, VentiAir s.r.o. reserves the right to refuse the warranty.

Version 01/2021



Regular
Production
Surveillance
Safety



www.tuv.com
ID: 6005073965



1 CONTENTS

1	Contents	3
2	Controller functions summary	5
3	Protection of the heat exchanger and the defrosting function	6
3.1	Inlet fan speed control:	6
3.2	System defrosting:	6
4	Heating/cooling mode	7
4.1	Enabling or shutting off the heating mode: the HDIS parameter	7
4.2	Enabling or shutting off the cooling mode: the CDIS parameter	7
4.3	Resetting the switching over of the heating and cooling mode	8
5	By-pass control	9
5.1	Heating mode	9
5.2	Cooling mode	9
6	Ground heat exchanger	9
6.1	Heating mode	9
6.2	Cooling mode	10
7	Inlet/outlet dampers	10
8	Recirculation dampers	10
9	Water heating coil pump	10
10	Preliminary heating control	11
11	Secondary heating control	11
12	CO2 control	11
13	Programming the fan speeds	11
14	Programming separate fan speeds:	12
15	User function:	12
16	Programming the controller functions	13
17	Modbus address setting	15
18	Terminals description	15
19	General information	16
20	Connection diagrams	16
21	Inputs/outputs description	18
22	Location of sensors	19
22.1	Basic system	19
22.2	Room temperature control by a secondary heater	19



22.3	Supply temperature control by a secondary heater	20
22.4	System with a secondary heater and a water cooler	20
22.5	System with preliminary heater to protect the heat exchanger	21
22.6	System with ground heat exchanger	21
23	MODBUS – List of registers with address	22
23.1	Holding registers description: functions 03, 06	22
23.2	Operating state register description	25
23.3	Alarm register description R1H, R1L	26
23.4	Input registers: function 04	26
23.5	Coils (Digital Outputs): function 01	27
23.6	Discret inputs (Digital inputs): function 02	27



Regular
Production
Surveillance
Safety

www.tuv.com
ID: 6005073965



2 CONTROLLER FUNCTIONS SUMMARY

- **Fans control**
 - Inlet and exhaust fan control
 - EC fan control
 - AC fan control (up to 4 speeds)
- **Heat recovery control**
 - By-pass control according to outdoor temperature
 - Active exchanger protection: temperature at the outlet of the exchanger is sensed and the speed of the inlet fan is controlled to keep the temperature at the exchanger outlet beyond the set level. When the temperature decreases below the alarm level then the inlet fan is switch off. The fan starts automatically after the temperature has increased beyond the protection level.
 - Exchanger control by primary electric heater control to keep a minimum temperature level at the outlet of the exchanger.
- **Ground heating exchanger control**
- **Connection of kitchen hood, humidistat, etc..**
- **Dirty filer alarm (6 month counter)**
 - By pressure guard (on request) with automatic clearing of alarm;
 - By a built in 6 month counter with alarm clearing by a switch on the ERC20 board or remotely by the RMC20 panel.
- **Temperature control**
 - Secondary heater control, both water heating coil and electric heater
 - Preliminary electric heater control to protect exchanger from freezing
 - Active Frost protection for water heating coils
 - Overheat protection of electric heaters
- **RS485 connection to the remote panel**
 - The controller communicates with a remote panel RMC20 via RS485 serial port. The panel enables remote setting of desired temperature, fan speed, parameters etc.. Alarms are also displayed.
- **Possibility of connection to a building management system (BMS)**
- **Real time clock with a week schedule**



3 PROTECTION OF THE HEAT EXCHANGER AND THE DEFROSTING FUNCTION

3.1 INLET FAN SPEED CONTROL:

The temperature at the heat exchanger outlet (sensor B2) is continuously sensed. When the temperature decreases below the set value **FMOD** the speed of the inlet fan is decreased successively up to the minimum value **FMIN** (default value is 10%). If meanwhile the temperature increases beyond the value **FMIN+1** then the programmed speed of the inlet fan will be restored and the speed modulation is cancelled.

If the temperature still decreases and falls below the alarm value **ELIM** (default value is 5°C) then the exchanger alarm is activated and the defrosting cycle starts.

3.2 SYSTEM DEFROSTING:

The heat exchanger defrosting is achieved by running the exhaust fan to high speed for a period of **2 to 5 minutes** (depending on the outside temperature), while the inlet fan is off. After the defrosting is ended, the exhaust fan returns to the programmed speed for **20 min** and the air supply fan still remains shut off, unless the exchanger frost alert was cancelled.

If after **20 min**, the temperature at the heat exchanger outlet is still lower than the alert level, the defrosting procedure is launched again.

The defrosting procedure ends when the temperature at the heat exchanger outlet rises above the alarm level.

Curve presenting the defrosting time in relation to the outside temperature:

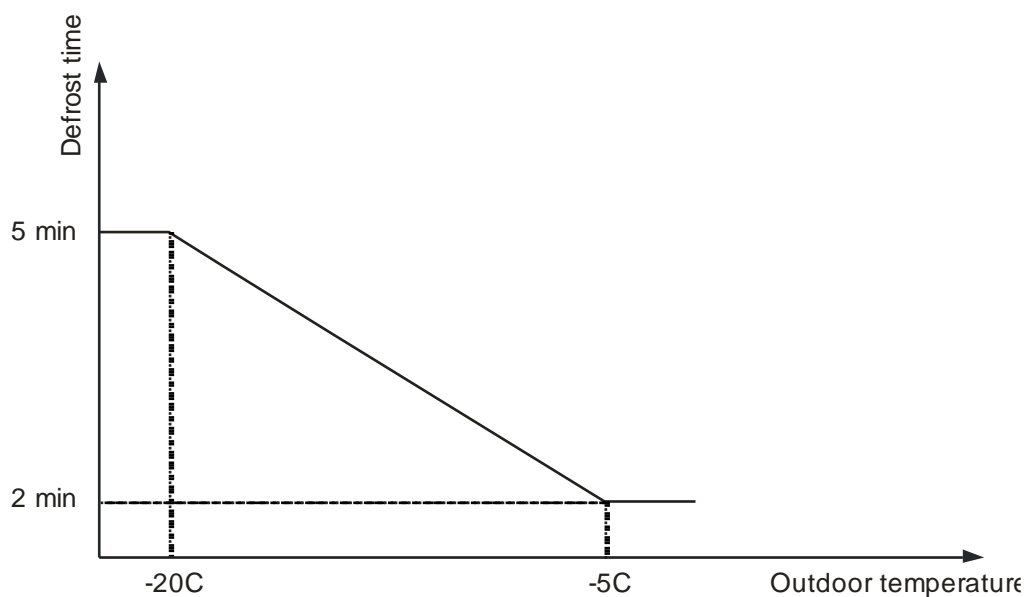

4 HEATING/COOLING MODE

4.1 ENABLING OR SHUTTING OFF THE HEATING MODE: THE HDIS PARAMETER

The **HDIS** parameter defines whether the heating mode is enabled or turned off.

When the outside temperature rises above the **HDIS** value, the heating mode is switched off.

When the temperature drops below this value by **1°C** which is below the **HDIS-1** value, the heating mode is enabled.

The default value of the parameter is **25°C**.

The heat recovery unit operates in the heating mode, if this mode is enabled and heating is needed, i.e. the set temperature is higher than the temperature in the room.

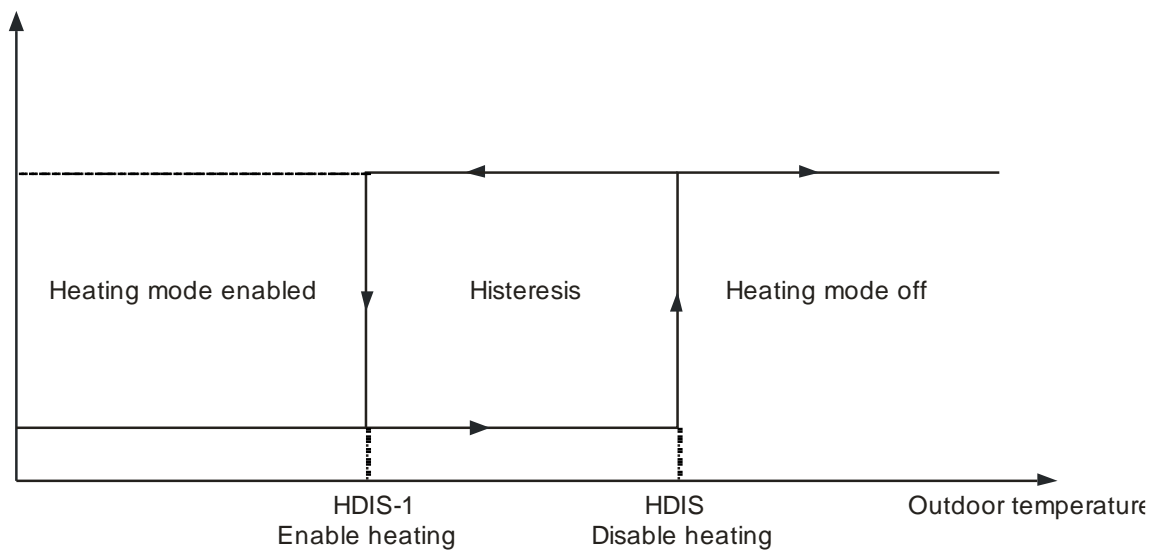

7

4.2 ENABLING OR SHUTTING OFF THE COOLING MODE: THE CDIS PARAMETER

The **CDIS** parameter defines whether the heating mode is enabled or turned off.

When the outside temperature drops below the **CDIS** value, the cooling mode is switched off.

When the temperature rises above this value by **1°C** which is above the **CDIS+1** value, the cooling mode is enabled.

The default value of the parameter is **15°C**.

The heat recovery unit operates in the cooling mode, if this mode is enabled and heating is needed, i.e. the set temperature is lower than the temperature in the room.

4.3 RESETTING THE SWITCHING OVER OF THE HEATING AND COOLING MODE

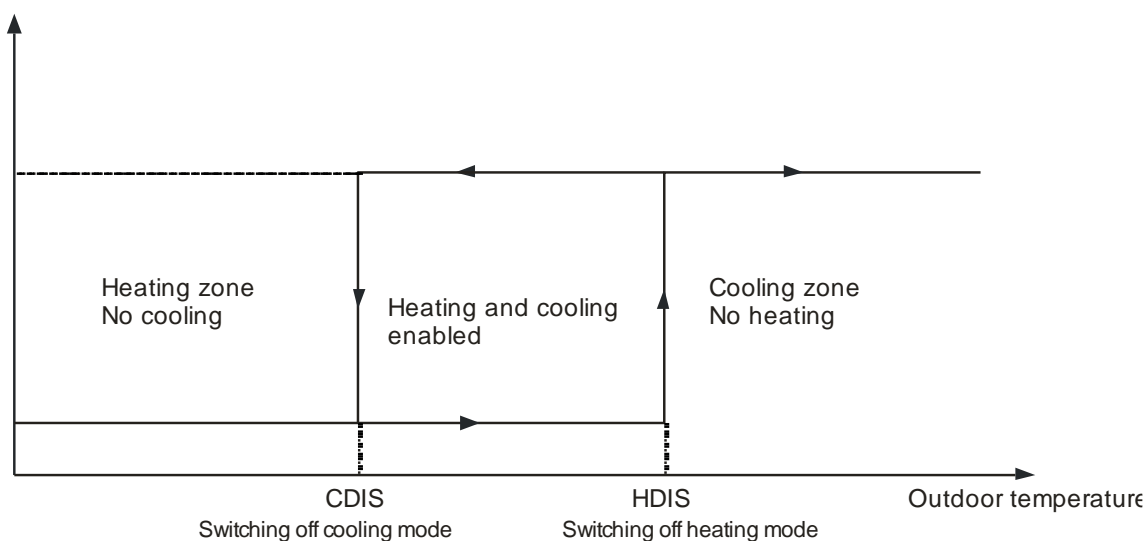
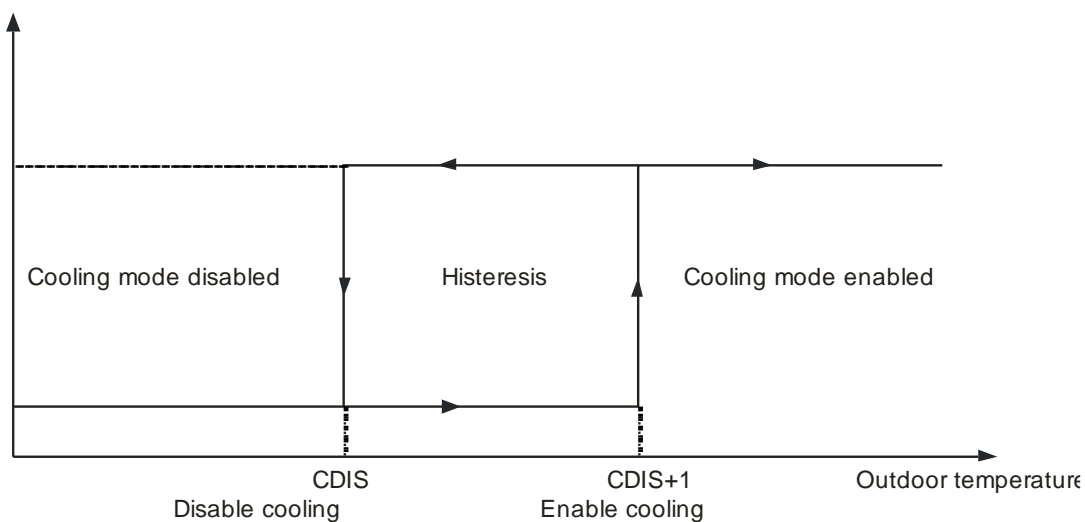

5 BY-PASS CONTROL

Controlling the by-pass air dampers takes place depending on outside temperature, ambient temperature and system operation mode (heating or cooling).

5.1 HEATING MODE

In the heating mode, the controller switches the by-pass off and intakes air through the heat exchanger if the ambient temperature exceeds the outside temperature by 2°C. On the other hand, if the ambient temperature does not exceed the outside temperature by more than 1°C, the controller opens the by-pass air dampers.

5.2 COOLING MODE

In the cooling mode, the controller switches the by-pass off and intakes air through the heat exchanger if the outside temperature exceeds the ambient temperature by 2°C. On the other hand, if the outside temperature does not exceed the ambient temperature by more than 1°C, the controller opens the by-pass air dampers.

6 GROUND HEAT EXCHANGER

Controlling the ground heat exchanger takes place depending on outside temperature, ambient temperature and system operation mode (heating or cooling). When the ground heat exchanger control is activated the **Q4** relay output will be set to control air dampers, therefore it is not available for connection of the fourth speed of an inlet AC fan or for inlet/outlet dampers control.

[Setting the ground heat exchanger control function is automatically done by connecting the sensor to B5 input.](#) The controller will detect the sensor and activate automatically the function.

6.1 HEATING MODE

In the heating mode, the controller switches the air dampers on by directing air through the ground heat exchanger when the temperature inside it exceeds the outside temperature by 2°C. On the other hand, if the temperature in the ground heat exchanger does not exceed the outside temperature by more than 1°C, the controller closes the air dampers.

6.2 COOLING MODE

In the cooling mode, the controller switches the air dampers on by directing air through the ground heat exchanger when the outside temperature exceeds the temperature in it by 2°C. On the other hand, if the outside temperature does not exceed the temperature in the ground heat exchanger by more than 1°C, the controller closes the air dampers.

7 INLET/OUTLET DAMPERS

If the ground heat exchange control function is not used, the **Q4** relay output may be used to control the inlet/outlet dampers. To program the **Q4** relay for this purpose, switch off the ground heat exchanger function (by not connecting a sensor to B5 input), then set the fan configuration to 3 speeds at a maximum or to the EC type fan. Then the **Q4** relay output will be configured to control the inlet/outlet dampers. The **Q4** output switches on when the unit is started and switches off when the unit is stopped or when the freeze protection alert is activated.

8 RECIRCULATION DAMPERS

10

The ERC20 controller has the possibility to control recirculation dampers via output **T3**. To activate this function set the switch **S1-4** to the position **ON**. When this function is activated up to two gears **AC fans** can be controlled. This does not affect **EC fans** control as it is controlled by analogue output and not the digital outputs.

When recirculation dampers are controlled the speed modulation of the inlet fan for exchanger frost protection will be disabled and the speed will be according to the programmed speed with the recirculation damper closed and the inlet/outlet dampers opened. When the exchanger frost protection alarm activates the inlet fan is stopped, the recirculation damper opened and the inlet/outlet dampers closed, the defrost cycle starts. After alarm is cancelled the inlet fan starts and the inlet/outlet dampers open.

9 WATER HEATING COIL PUMP

If the controller is set for EC fans control, then **T7** output will be set for water heating coil pump control. If the fans are AC fans and the chiller cooling function is deactivated, then the **Q8** output will be programmed to control a water heating coil pump.



Regular
Production
Surveillance
Safety
www.tuv.com
ID: 6005073965

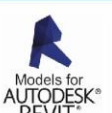

10 PRELIMINARY HEATING CONTROL

The controller allows preliminary heater control in order to initially heat up the inlet air to a level (default value is **8°C**) that will avoid the exchanger frost protection system to activate, thus allowing the inlet fan to run with a constant speed with no speed modulation. The output for the preliminary heating is set to **P1** modulated output for electric heaters.

11 SECONDARY HEATING CONTROL

Supply air or room temperature control are done by a secondary heater mounted after the exchanger. The ERC20 controller allows to control both water heating coil and electric heater.

The **Y4** analogue output is set to control water heating coil valve actuator, while **P2** modulated output is set for electric heater control.

The desired temperature is set from the RMC20 panel.

12 CO2 CONTROL

By connecting a 0-10V CO2 transmitter to **X1** analog input, CO2 control can be done by automatic fans speed regulation. The controller regulates the fans speed to make the sensed CO2 value match with the desired value.

Activating the CO2 control function is automatically done by connecting a 0-10V CO2 transmitter to **X1** input.

11

13 PROGRAMMING THE FAN SPEEDS

From the level of the RMC20 panel, rotations of fans may be programmed for particular speeds: The parameters are as follows:

- SPD1: fan speed for the first gear.
- SPD2: fan speed for the second gear
- SPD3: fan speed for the third gear
- SPD4: fan speed for the fourth gear

14 PROGRAMMING SEPARATE FAN SPEEDS:

The EC20 controller allows to program separate speeds for the air supply fan and the exhaust fan. The dependence between the fans is set from the level of the RMC20 panel and is determined by the **FCOEF** parameter. This parameter may be set within the range of **0.5÷2.0** and the dependency between the air supply fan and the exhaust fan is as follows:
Exhaust = Air supply x FCOEF.

The selection of speeds or rotations of the fans relates to the air supply fan, while the rotations of the exhaust fan are calculated based on the air supply fan rotations and the value of the FCOEF ratio.

Note: This dependency applies only in case of normal mode of operation, when the defrosting procedure is not carried out and the temperature at the heat exchanger outlet does not drop to the level which switches on the automatic control of air supply fan control in order to protect the heat exchanger.

15 USER FUNCTION:

The **E4** digital input of the ERC20 controller can be configured as input to execute some specific functions called user function.

From the menu of the RMC20 panel you can select one of the following functions to be executed when the signal on the **E4** input is activated (short-circuit on the input):

MODE	Performed function
OFF	The user function is off and signal at the E3, E4 input of the controlled has no effect
1	The air supply fan is running with the maximum speed The air exhaust fan is running with the maximum speed
2	The air supply fan is running with the first speed The air exhaust fan is running with the maximum speed
3	The air supply fan is off The air exhaust fan is running with the maximum speed
4	The air supply fan is running with the minimum speed The air exhaust fan is running with the minimum speed
5	The air supply fan is running with the maximum speed The air exhaust fan is running with the first speed
6	The air supply fan is running with the maximum speed The air exhaust fan is off

A kitchen hood or a hygostat or any other device that will perform the selected function may be connected to the **E4** input.

16 PROGRAMMING THE CONTROLLER FUNCTIONS

Broken down by switch:

Switch	Position	Function
S1-1	low	2 speeds - Fan with step control of rotations
S1-2	low	
S1-1	high	3 speeds - Fan with step control of rotations
S1-2	low	
S1-1	low	4 speeds - Fan with step control of rotations
S1-2	high	
S1-1	high	EC fan - stepless control
S1-2	high	
S1-3	low	Water heater
	high	Electric heater
S1-4	low	No recirculation dampers
	high	Recirculation dampers Control at output T3 <i>Output T1 and T2 for AC fans control (max. 2 speed)</i>
S2-1	low	System without by-pass
	high	System with by-pass
S2-2	low	By-pass control by output closing contact
	high	By-pass control by output open contact
S2-3	low	Water cooling on Y3 output (no preliminary heating on Y3)
	high	Chiller cooling on Q8 output (preliminary heating on Y3)
S2-4	low	Preliminary heating on Y3 output; no cooling functions
	high	Cooling function on Y3 or Q8 output



Broken down by function:

Functions	Switch
Fan selection	
Fan with step control of rotations	S1-1 low
EC fan, stepless control of rotations	S1-1 high
Number of speeds and type of fan	
2 speeds - Fan with step control of rotations	S1-1 low S1-2 low
3 speeds - Fan with step control of rotations	S1-1 high S1-2 low
4 speeds - Fan with step control of rotations	S1-1 low S1-2 high
EC fan - stepless control	S1-1 high S1-2 high
Heater selection	
Water heater	S1-3 low
Electric heater	S1-3 high
Recirculation dampers control	
No recirculation dampers	S1-4 low
Recirculation dampers Control at output T3 <i>Output T1 and T2 for AC fans control (max. 2 speed)</i>	S1-4 high
By-pass selection	
System without by-pass	S2-1 low
System with by-pass	S2-1 high
By-pass control mode	
By-pass control by output closing contact	S2-2 low
By-pass control by output open contact	S2-2 high
Cooling type	
Chilled water cooling on Y3 output	S2-3 low
Chiller cooling on Q8 output	S2-3 high
Cooling and preliminary heating function	
The preliminary heater on Y3 output; no cooling function	S2-4 low
Cooling function on Y3 or Q8 output; no preliminary heater	S2-4 high



17 MODBUS ADDRESS SETTING

S1				S2				Address
1	2	3	4	1	2	3	4	
<input type="checkbox"/>	<input type="checkbox"/>	<input type="checkbox"/>	<input type="checkbox"/>	<input type="checkbox"/>	<input type="checkbox"/>	<input type="checkbox"/>	<input type="checkbox"/>	0
<input type="checkbox"/>	<input type="checkbox"/>	<input type="checkbox"/>	<input type="checkbox"/>	<input type="checkbox"/>	<input type="checkbox"/>	<input type="checkbox"/>	<input checked="" type="checkbox"/>	1
<input type="checkbox"/>	<input type="checkbox"/>	<input type="checkbox"/>	<input type="checkbox"/>	<input type="checkbox"/>	<input type="checkbox"/>	<input checked="" type="checkbox"/>	<input type="checkbox"/>	2
<input type="checkbox"/>	<input type="checkbox"/>	<input type="checkbox"/>	<input type="checkbox"/>	<input type="checkbox"/>	<input type="checkbox"/>	<input checked="" type="checkbox"/>	<input checked="" type="checkbox"/>	3
<input type="checkbox"/>	<input type="checkbox"/>	<input type="checkbox"/>	<input type="checkbox"/>	<input type="checkbox"/>	<input type="checkbox"/>	<input type="checkbox"/>	<input type="checkbox"/>	
<input type="checkbox"/>	<input type="checkbox"/>	<input type="checkbox"/>	<input type="checkbox"/>	<input type="checkbox"/>	<input type="checkbox"/>	<input type="checkbox"/>	<input type="checkbox"/>	
<input checked="" type="checkbox"/>	<input checked="" type="checkbox"/>	<input checked="" type="checkbox"/>	<input checked="" type="checkbox"/>	<input checked="" type="checkbox"/>	<input checked="" type="checkbox"/>	<input checked="" type="checkbox"/>	<input checked="" type="checkbox"/>	255

To set the Modbus address of the controller the same switches are used as for setting the functions. First, set the address according to the table and press the button S4 to save the set value in the memory. After pressing the button the leds will flash to acknowledge the memorising of the address. From now you can use the same switches to program the controller functions.

18 TERMINALS DESCRIPTION

- L-N** 230 VAC power supply
 - M** Signal ground
 - B1-B4** Resistance inputs PT1000
 - E1-E5** Digital inputs – voltage free contacts
 - T1-T7** 230 VAC high-voltage outputs
 - Q4,Q8** Relay output – normally open contacts
 - Y1-Y4** 0-10V DC voltage outputs
 - P1, P2** 24V DC modulated outputs: for a stepless control of electric air heaters
- The controlled device (e.g. a solid-state relay) must be connected between P1 (+) and ground M (-) or P2 (+) and ground M (-).
- A1, B1** RS485 serial connection No. 1
 - A2, B2** RS485 serial connection No. 2



19 GENERAL INFORMATION

Power supply voltage:	230 VAC \pm 10%, 50/60Hz
Power consumption:	6VA (P1, P2 outputs not loaded)
Ambient temperature:	0...50°C
Storage temperature:	-25...50°C

Inputs:

Resistance inputs B1...B5	PT1000 type, range: -25 ...+70°C
Digital E1-E5	Input signal: voltage free contacts

Outputs:

Analogue Y1-Y4	0-10V / 2mA
Modulated P1, P2	24V / 50mA (max.) Output resistance: 200 Ω
Relay Q8	250VAC, 5A / resistive load
High voltage T1-T7	230 VAC / 5A max

Compliant with  This product is compliant with the requirements set out by the European Standards PN-EN 61131-2 regarding electromagnetic compatibility, and is provided with CE mark.

20 CONNECTION DIAGRAMS

Connection with EC fans and cooling function:



Regular
Production
Surveillance
Safety
www.tuv.com
ID: 6005073965



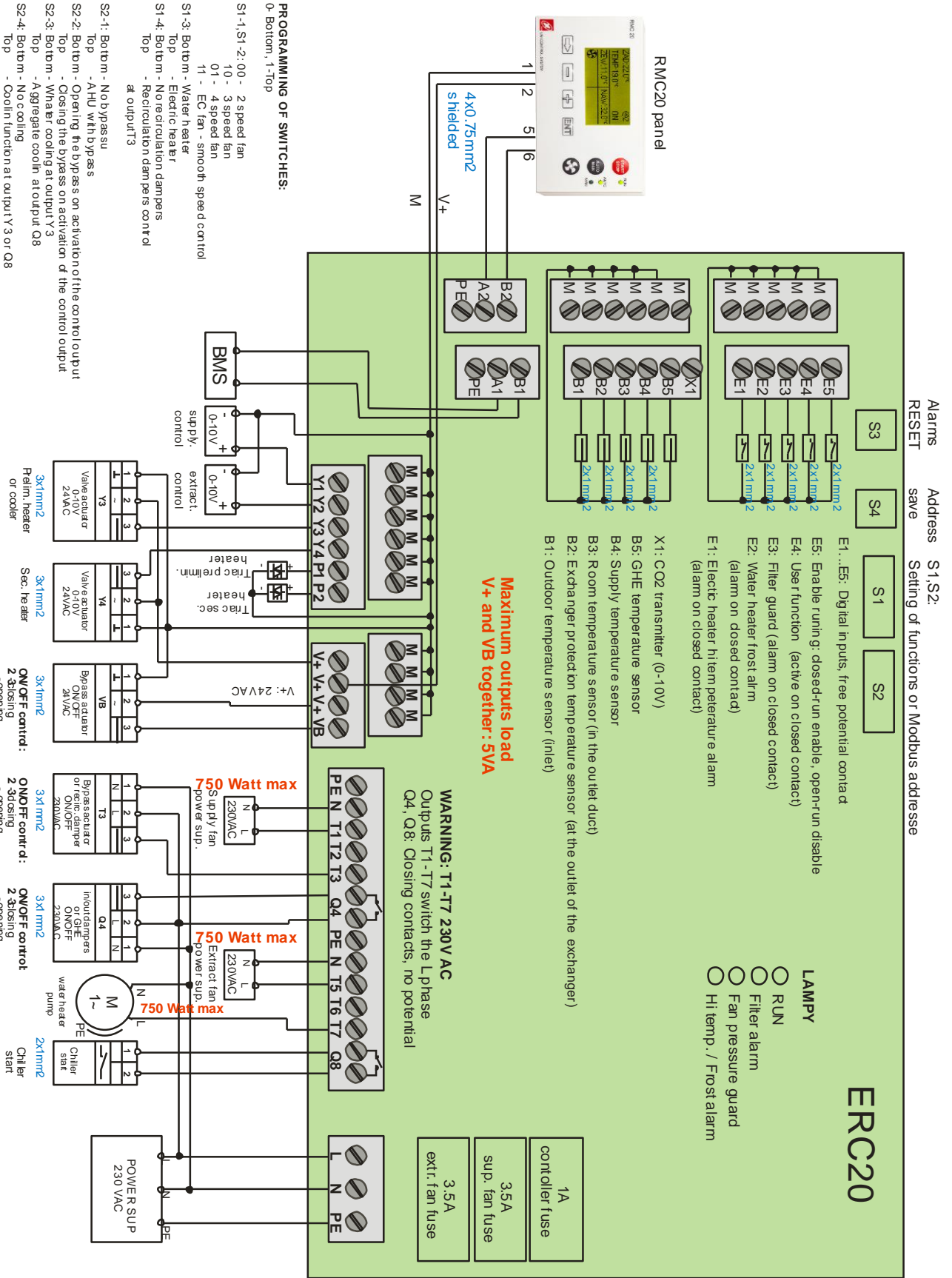

21 INPUTS/OUTPUTS DESCRIPTION

AI	B1	PT1000	Outdoor temperature sensor (Inlet)
	B2	PT1000	Exchanger protection temperature sensor (outlet of the exchanger)
	B3	PT1000	Room temperature sensor (extract air)
	B4	PT1000	Supply air temperature sensor
	B5	PT1000	Ground heat exchanger temperature sensor
	X1	0-10V	0-10V CO2 transmitter
DI	E1	Free contact	Hi temperature alarm for electric heater (alarm when opened contact)
	E2	Free contact	Frost alarm for water heater (alarm when opened contact)
	E3	Free contact	User function 1 (active when closed contact)
	E4	Free contact	User function 2 (active when closed contact)
	E5	Free contact	Switch ON/OFF the unit
AO	Y1	0-10V	Inlet fan control
	Y2	0-10V	Exhaust fan control
	Y3	0-10V	Preliminary heater valve actuator control (for exchanger protection) or cooler valve actuator control
	Y4	0-10V	Secondary heater valve actuator control (supply air heating)
PWM	P1	21V / 50mA	Modulated output for preliminary electric heater (SSR control)
	P2	21V / 50mA	Modulated output for secondary electric heater (SSR control)
DO	T1	230 VAC	Inlet fan supply
	T2	230 VAC	-
	T3	230 VAC	By-pass actuator (230V AC)
	Q4	Free contact	Inlet/outlet damper or ground heat exchanger control relay contact
	T5	230 VAC	Outlet fan supply
	T6	230 VAC	-
	T7	230 VAC	Heater circulation pump
	Q8	Free contact	Cooling compressor start/stop relay contact
	VB	24 VAC	By-pass actuator (24V AC)



22 LOCATION OF SENSORS

22.1 BASIC SYSTEM

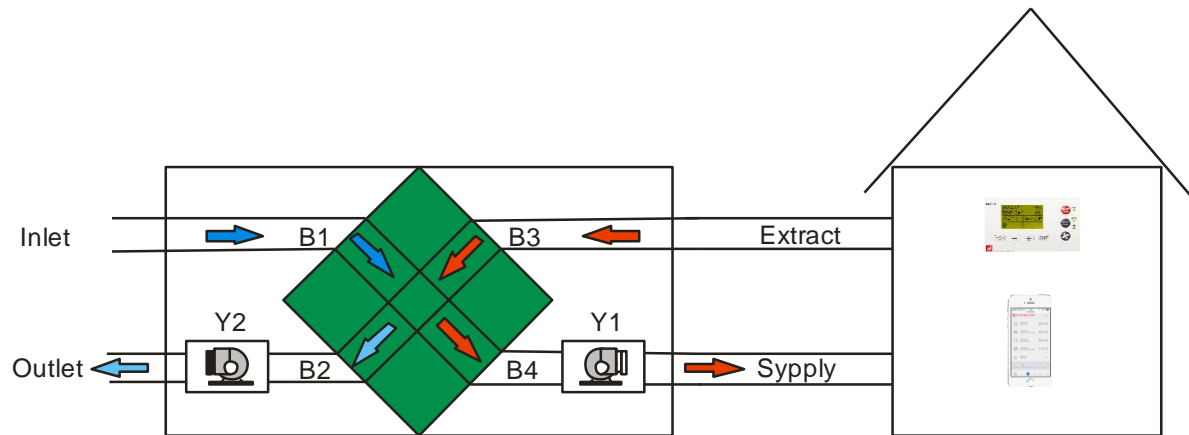

22.2 ROOM TEMPERATURE CONTROL BY A SECONDARY HEATER

The controller maintains the desired temperature in the room by sensing the temperature on sensor **B3** located in the exhaust duct, while the sensor **B4** located after the heater is used to limit the supply temperature within the minimum and maximum values. The default settings are 15°C and 35°C.

The outputs **Y4** and **P2** are set for heating control, **Y4** for water heating coil valve actuator, and the modulated output **P2** for the electric heater control.

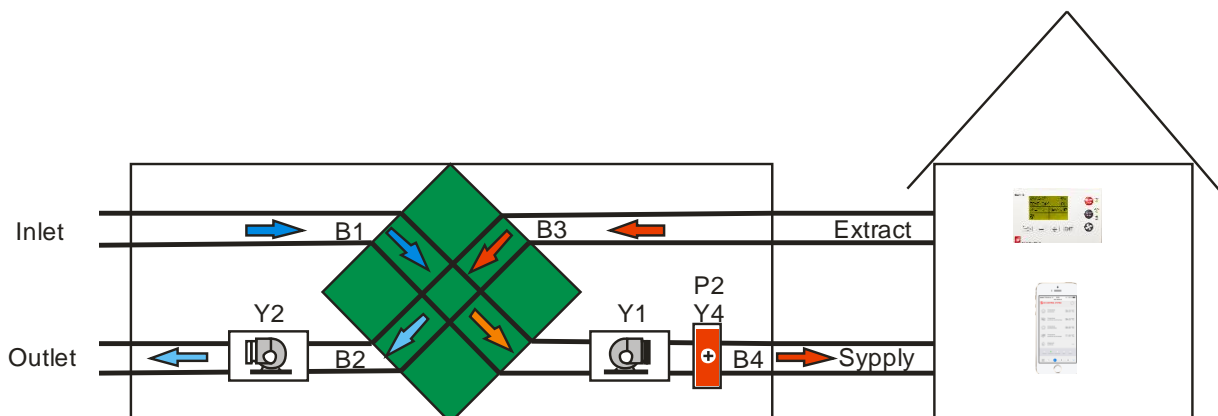

22.3 SUPPLY TEMPERATURE CONTROL BY A SECONDARY HEATER

To make a supply temperature control, **just remove the exhaust duct sensor**. The controller switches to supply control on sensor **B4** when the exhaust duct sensor **B3** is not detected.

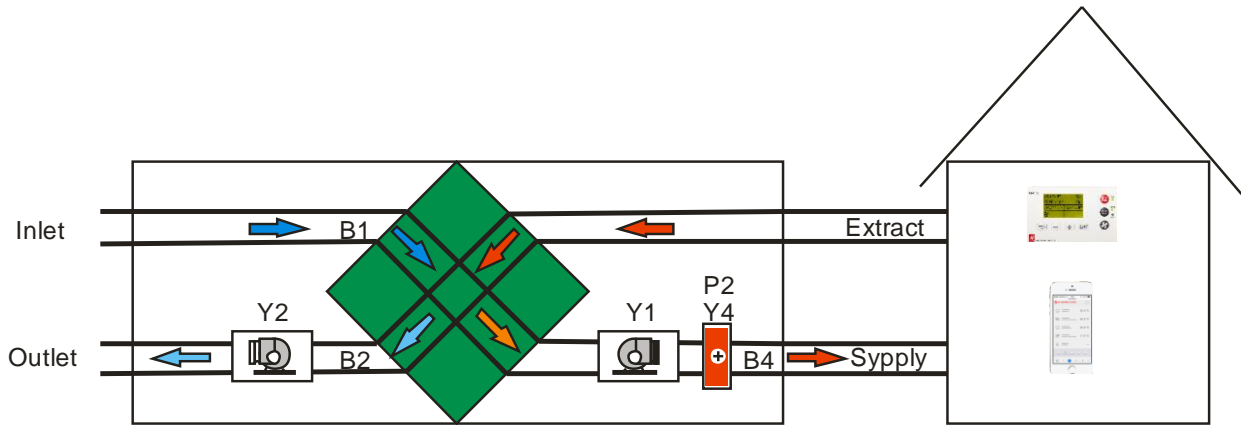

22.4 SYSTEM WITH A SECONDARY HEATER AND A WATER COOLER

The controller maintains the desired temperature in the room by sensing the temperature on sensor **B3** located in the exhaust duct, while the sensor **B4** located after the heater and the cooler is used to limit the supply temperature within the minimum and maximum values. The default settings are **15°C** and **35°C**.

The outputs **Y4** and **P2** are set for heating control, **Y4** for water heating coil valve actuator, and the modulated output **P2** for the electric heater control, while the output **Y3** is set to control the water cooler valve actuator.

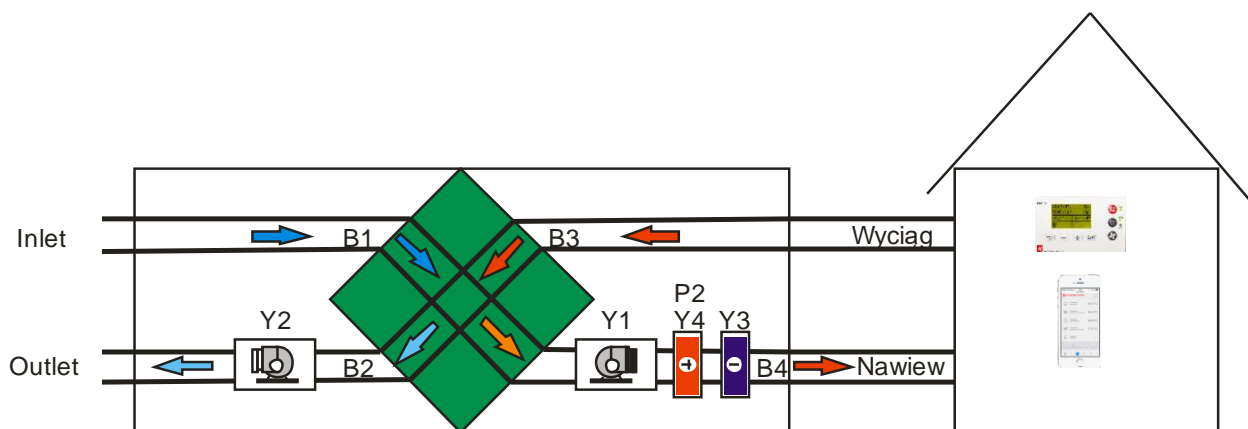

22.5 SYSTEM WITH PRELIMINARY HEATER TO PROTECT THE HEAT EXCHANGER

By using a preliminary heater mounted at the inlet we can protect the exchanger against freezing. The reference sensor for the preliminary heating control is the sensor **B2** at the heat exchanger outlet and the default desired value is set to 8°C. The modulated output **P1** is set for the preliminary electric heater control to prevent a drop of temperature below the set value at the outlet of the exchanger.

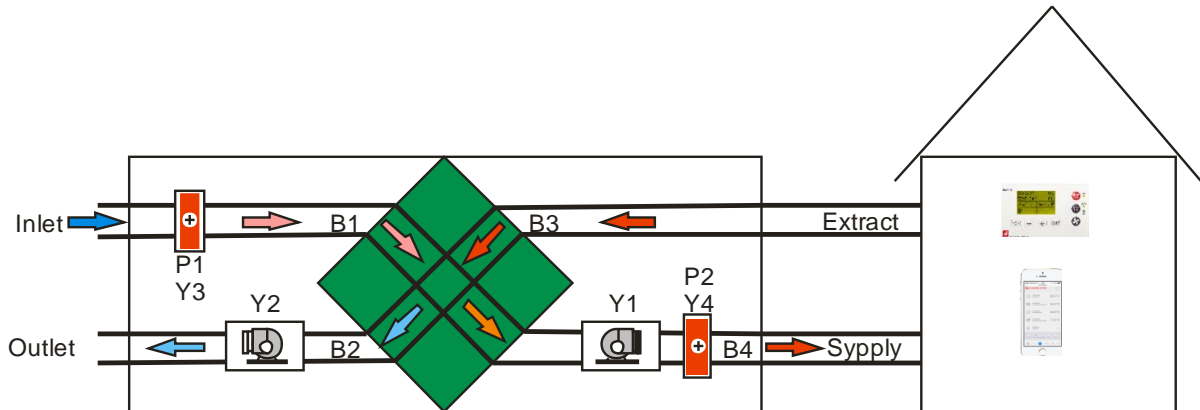

22.6 SYSTEM WITH GROUND HEAT EXCHANGER

The outdoor sensor **B1** should be installed before the ground heat exchanger or outside the building to indicate the real outdoor temperature, while the sensor **B5** should be installed in the ground heat exchanger inlet.

The relay output **Q4** is set to control the dampers of the ground heat exchanger. The controller switches on the **Q4** output once every hour in order to make the air flow through the ground heat exchanger and make a temperature measurement. If the conditions are met (temperature higher than outdoor temperature by 2°C for heating mode, or temperature lower than outdoor temperature by 2°C for cooling mode), the output **Q4** remain switch on and the air flows through the ground heat exchanger to the plate or rotary exchanger. However, if the conditions are not met, the output **Q4** is switched off, and the air will bypass the ground heat exchanger.

B1: Outdoor sensor
 B5: Air temperature sensor inside the ground heating exchanger (GHE)
 Q4: GHE damper control output

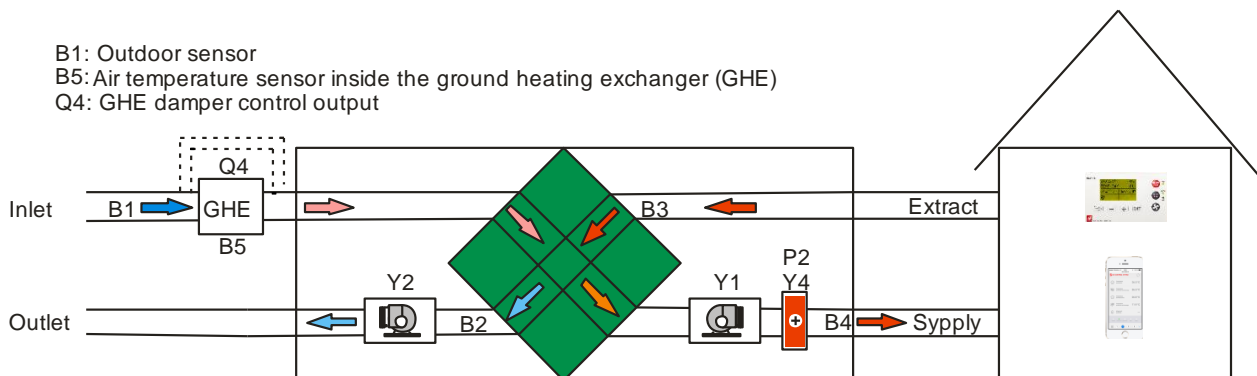

23 MODBUS – LIST OF REGISTERS WITH ADDRESS

Protocol:	MODBUS RTU or ASCII (See information on the RMC20 display)
Baud rate:	9600
Bit number:	8
Parity:	No
Stop bit:	1
Slave address:	1

Warning:

MODBUS address is the address that is specified directly in the MODBUS protocol frame, Registers in the controller have double Modbus address. The second address is for use in the range from 0 to 9999 because not all software are able to use address above 9999. To have access to the second address just subtract the value **55536** from the address listed in the tables.

23.1 HOLDING REGISTERS DESCRIPTION: FUNCTIONS 03, 06

Register Name	Register	MODBUS Address
PWM outputs P <i>NOTE:</i> 1. Control values are in w % with 1/10 precision. After reading the register value the dot should be placed artificially Ex.: Reading the value 257 should be treated as 25.7% 2. The value 0x8000 means, the parameter is not available.	0 – P1 1 - P2 ... n - Pn	65472 65473 ... 65472+n
0-10V analog outputs <i>NOTE:</i> 1. Control values are in w % with 1/10 precision. After reading the register value the dot should be placed artificially Ex.: Reading the value 257 should be treated as 25.7% 2. The value 0x8000 means, the parameter is not available.	0 – Y1 1 – Y2 ... n – Yn	65408 65409 65408+n
Alarms register bit alignment Read and write Alarms register are 32-bit wide (see the description of registers in point 4)	0 – 1 – R1H: current alarm - High register 2 – R1L: current alarm – Low register	65280 65281 65282
Desired values: read/write	0 – Desired temperature for the main heating/cooling..... 3 – Fan gear Writing- 5 values: 0 – Gear according to the controller setting 1 – gear 1 2 – gear2 3 – gear3 4 – gear4 Reading- 4values: 0 – gear 1	65216 65219



	1 – gear 2 2 – gear 3 3 – gear 4 4 – Running mode Writing - 3 values: 0 – Running mode according to the controller setting 1 – AUTOMATIC 2 – MANUAL Reading - 2 values: 0 – AUTOMATIC 1 – MANUAL 5 – Desired temperature for preliminary heater 7 – Fan running speed	65220 65221 65223
Device operating state	0 – Register 1 1 – Register 2	65152 65153
Sensed values 1. The sensed values have 1/10 precision. After reading the sensed value it should be divided by 10. Ex: Reading the number 257 should be treated as 25.7 2. Reading the value 0xFFFF means that , the parameter does not exist	0 – Indoor temperature..... 3 – Supply temperature..... 6 – Outdoor temperature..... 8 – Exchanger exhaust air temperature..... 25-Ground Heating Exchanger temperature.....	64896 64899 64902 64904 64921
Control values NOTE: 1. Control values are in w % with 1/10 precision. After reading the register value the dot should be placed artificially Ex.: Reading the value 257 should be treated as 25.7% 2. The value 0x8000 means, the parameter is not available.	0 – Primary (main) heating control: 0-100%..... 1 – 2 – Cooling control: 0-100%..... 12–Inlet fan control..... 13–Outlet fan control.....	64832 ----- 64834 64844 64845
Start/Stop command and system operating state	0 –Start/Stop command Write: Start=0x00AA, Stop=0x0055 Read: System operating state 0 – system stopped by the operator 1 – system stopped by the ECO mode function 2 – system stopped by schedule 3 – 4 – 5 – System running	64640
Alarms Writing value 170 (0xAA) to address 64576 clears all alarms. Reading from this address informs about any alarm. Reading 0 – no alarm, 1 – an alarm occurred. To clear specific alarm write to the corresponding address the value 170 .	0: Alarm (informs about Any alarm)..... 1: A1 – Frost alarm..... 2: A2 – Motor alarm..... 3: A3 – Supply fan pressure guard alarm..... 4: A4 – Extract fan pressure guard alarm..... 5: A5 – Fire alarm..... 6: A6 – High temperature alarm..... 7: A7 – Exchanger freezing alarm..... 8: A8 – Refrigeration unit alarm..... 9: A9 – Pump failure alarm..... 10: A10 – Filter alarm..... 18: A18 – Sensor break alarm.....	64576 64577 64578 64579 64580 64581 64582 64583 64584 64585 64586 64594 64598 64599



	22: A22 – Compressor low pressure.....	
	23: A23 – Compressor high pressure.....	
Start time <i>Writes to memory</i>	<p>0 – for all time zones and programs</p> <p>1 – for all time zones 1.....</p> <p>2 – for all time zones 2.....</p> <p>3 – for all time zones 3.....</p> <p>4 – for all time zones 4.....</p> <p>5 – for all time zones 5 (not available).....</p> <p>6 – for all manual mode programs</p> <p>7 – Monday – zone 1.....</p> <p>8 – Monday – zone 2.....</p> <p>9 – Monday – zone 3.....</p> <p>10 – Monday – zone 4.....</p> <p>11 – Monday – zone 5.....</p> <p>12 – Monday – manual program.....</p> <p><i>Nx6+1 – zone 1</i></p> <p><i>Nx6+2 – zone 2</i></p> <p><i>Nx6+3 – zone 3</i></p> <p><i>Nx6+4 – zone 4</i></p> <p><i>Nx6+5 – zone 5</i></p> <p><i>Nx6+6 – manual program</i></p> <p><i>N – day of the week, 1-monday, 2-tuesday, ...</i></p> <p>Address = offset address + Nx6 + zone nr</p>	<p>63680</p> <p>63681</p> <p>63682</p> <p>63683</p> <p>63684</p> <p>63685</p> <p>63686</p> <p>63687</p> <p>63688</p> <p>63689</p> <p>63690</p> <p>63691</p> <p>63692</p> <p>...</p> <p>...</p> <p>...</p> <p>...</p> <p>...</p> <p>...</p>
Stop time	<p>0 – for all time zones and programs</p> <p>1 – for all time zones 1.....</p> <p>2 – for all time zones 2.....</p> <p>3 – for all time zones 3.....</p> <p>4 – for all time zones 4.....</p> <p>5 – for all time zones 5 (not available).....</p> <p>6 – for all manual mode programs</p> <p>Similar to the start time</p>	<p>63616</p> <p>63617</p> <p>63618</p> <p>63619</p> <p>63620</p> <p>63621</p> <p>63622</p>
Desired temperature for secondary heater	<p>0 – for all time zones and programs</p> <p>1 – for all time zones 1.....</p> <p>2 – for all time zones 2.....</p> <p>3 – for all time zones 3.....</p> <p>4 – for all time zones 4.....</p> <p>5 – for all time zones 5.....</p> <p>6 – for all manual mode programs</p> <p>Similar to the start time</p>	<p>63552</p> <p>63553</p> <p>63554</p> <p>63555</p> <p>63556</p> <p>63557</p> <p>63558</p>
Fan gear	<p>0 – for all time zones and programs</p> <p>1 – for all time zones 1.....</p> <p>2 – for all time zones 2.....</p> <p>3 – for all time zones 3.....</p> <p>4 – for all time zones 4.....</p> <p>5 – for all time zones 5 (not available).....</p> <p>6 – for all manual mode programs</p> <p>Similar to the start time</p>	<p>63296</p> <p>63297</p> <p>63298</p> <p>63299</p> <p>63300</p> <p>63301</p> <p>63302</p>

23.2 OPERATING STATE REGISTER DESCRIPTION

Register 1

Bit nr	Process	Availability
0		No
1		No
2		No
3		No
4		No
5		No
6	<i>Delay at start of the unit</i>	No
7	Delay at stop of the unit	
8 - 10	Device state: 0 - system stopped by the operator 1 - system stopped by the ECO mode function 2 - system stopped by schedule 3 - 4 - 5 - System running	
11	<i>Valve setting before starting control</i>	No
12	<i>Pump testing</i>	No
13	Temperature control of the preliminary heater – heating process	
14	<i>Temperature control of the preliminary heater – cooling process</i>	No
15	Exchanger defrosting process	

25

Register 2

Bit nr	Process	Availability
0	Primary heating (main heating) – Indoor temperature control	
1	<i>Secondary heating</i>	No
2	Cooling – Indoor temperature control	
3	Exchanger exhaust air temperature control - heating	
4		No
5	<i>Humidification process</i>	No
6	<i>Dehumidification process</i>	No
7	Exchanger	
8	By-pass	
9	GHE (Ground Heating Exchanger)	
10	Inlet fan	
11	Extract fan	
12	<i>FREE COOLING</i>	No
13	<i>Preliminary heating</i>	No
14	<i>Fast heating</i>	No
15	<i>Fast cooling</i>	No

0 – OFF; 1 – ON



Regular
Production
Surveillance
Safety

www.tuv.com
ID: 6005073965



23.3 ALARM REGISTER DESCRIPTION R1H, R1L

RH - Register 1 (Most significant/high register)

Bit nr.	Alarm	Symbol	Availability
0		<i>RH+</i>	<i>No</i>
1		<i>RH-</i>	<i>No</i>
2		<i>A19</i>	<i>No</i>
3	Sensor break alarm	A20	
4	-		
5		<i>A22</i>	<i>No</i>
6		<i>A23</i>	<i>No</i>
7..15			

RL - Register 2 (Least significant/low register)

Bit nr.	Alarm	Symbol	Availability
0	Water heating coil frost alarm	A1	
1	<i>Engine alarm (thermistor)</i>	<i>A2</i>	<i>No</i>
2	Inlet fan pressure guard alarm	A3	
3	<i>Extract fan pressure guard alarm</i>	<i>A4</i>	<i>No</i>
4	<i>Fire alarm</i>	<i>A5</i>	<i>No</i>
5	High temperature alarm	A6	
6	Exchanger freezing alarm	A7	
7	<i>anti-freeze alarm</i>	<i>A8</i>	<i>No</i>
8	<i>Pump failure</i>	<i>A9</i>	<i>No</i>
9	Filter pressure guard alarm	A10	
10		<i>R1+</i>	<i>No</i>
11		<i>R1-</i>	<i>No</i>
12		<i>R2+</i>	<i>No</i>
13		<i>R2-</i>	<i>No</i>
14		<i>R3+</i>	<i>No</i>
15		<i>R3-</i>	<i>No</i>

23.4 INPUT REGISTERS: FUNCTION 04

Input type	Most significant/high byte (Segment)	Least significant/low byte (Offset)
Resistive inputs B	0	0 – B1 1 – B2 ... n – Bn
Analog inputs 0-10V	1	0 – X1 1 – X2 ... n – Xn

23.5 COILS (DIGITAL OUTPUTS): FUNCTION 01

Output	T1	T2	T3	Q4	T5	T6	T7	Q8
Function			Bypass-230V	Ground heating exch.			Heating pump	Cooling compressor
Address	0	1	2	3	4	5	6	7

23.6 DISCRET INPUTS (DIGITAL INPUTS): FUNCTION 02

Input	E1	E2	E3	E4	E5			
Function	Hi temp. Alarm for el. heater	Frost alarm	User func 1	User func 2	Start/stop			
Address	0	1	2	3	4	5	6	7



Regular
Production
Surveillance
Safety



www.tuv.com
ID: 6005073965

